



SPECIFICATIONS

DN mm	DN40 - DN500
DN inch	1"1/2 - 20"
Temperature	0°C to 80°C
Type of body	Double flanges
Application	Clear water, Fire protection, Irrigation, Sewage
Flange	PN 10, PN 16
Valve Standard	EN 1171, EN 1074
Face to face	EN 558-1, DIN 3202 F5
Flange drilling	EN 1092-2
Tightness test	EN 12266-1
Epoxy coating	150µm (standard), other thickness on request
Options	Other specifications on request

ADVANTAGES

1. Excellent performance : low pressure drop and low torque.
2. Full bore design.
3. Wedge fully encapsulated in moulded EPDM.
4. Linear sealing design provides better sealing and lower closing torque.
5. Three independant stem seals offering triple safety : PTFE dust cover protects against dirt outside and a polyamid bearing with 3 NBR O-rings protects against galvanic corrosion.
6. Operation : valve could be operated by hand wheel/head cap/worm gear/electric actuator.

DIMENSIONS

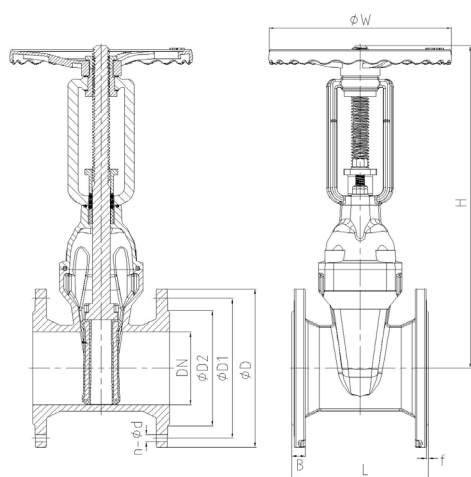

DN mm	DN inch	PFA	L	ØD	ØD1	ØD2	B	f	H	ØW	n-Ød
40		16	240	150	110	84	19	3	290	200	4-Ø19
50	2"	16	250	165	125	99	19	3	290	200	4-Ø19
65		16	270	185	145	118	19	3	350	200	4-Ø19
80	3"	16	280	200	160	132	19	3	375	200	8-Ø19
100	4"	16	300	220	180	156	19	3	450	254	8-Ø19
125	5"	16	325	250	210	184	19	3	510	315	8-Ø19
150	6"	16	350	285	240	211	19	3	585	315	8-Ø23
200	8"	16 10	400	340	295	266	20	3	735	315	12-Ø23 8-Ø23
250	10"	16 10	450	405 395	355 350	319	22	3	875	406	12-Ø28 12-Ø23
300	12"	16 10	500	460 445	410 400	370	25	4	1015	406	12-Ø28 12-Ø23
350	14"	16 10	550	520 505	470 460	429	27	4	1210	500	16-Ø28 16-Ø23
400	16"	16 10	600	580 565	525 515	480	28	4	1335	500	16-Ø31 16-Ø28
450	18"	16 10	650	640 615	585 565	548 530	30	4	1515	650	20-Ø31 20-Ø28
500	20"	16 10	700	715 670	650 620	609 582	32	4	1600	650	20-Ø34 20-Ø28

NOMENCLATURE

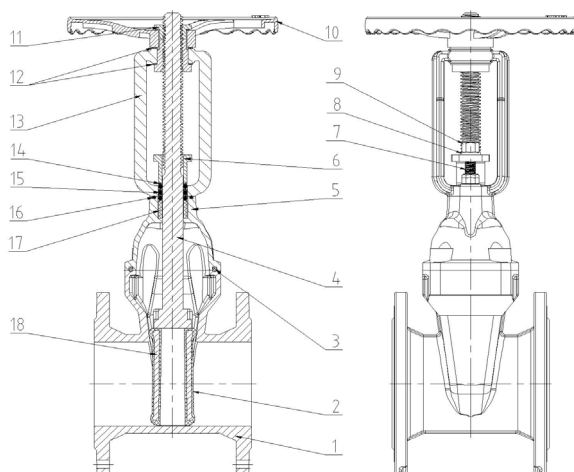

Designation	Materials
1.Body	Ductile iron GGG50 epoxy coated
2.Disc	Ductile iron GGG50 with EPDM coating
3.Bonnet Gasket	NBR
4.Stem	Stainless steel 420
5.Bonnet	Ductile iron GGG50 epoxy coated
6.Gland	Ductile iron GGG50 epoxy coated
7.Bolt	Stainless steel 304
8.Washer	Stainless steel 304
9.Nut	Stainless steel 304
10.Handwheel	Ductile iron GGG50 epoxy coated
11.Stem nut	Brass CuZn39Pb1
12.Friction pads	Stainless steel 304
13.Yoke	Ductile iron GGG50 epoxy coated
14.Gasket	POM
15.O-ring	NBR
16.O-ring	NBR
17.Washer	Phenolic PF
18.Disc core	Ductile iron GGG50

